



BC... type pilot operated check valves - 3 way

- Poppet type
- From SAE08 to SAE10 cavities

Technical specifications and diagrams are measured with mineral oil of 46 cSt viscosity at 40°C (104°F) temperature.

	BC08A	BC10A-B	BC10C	BC12A-B	BC16A-B
Nominal flow	15 l/min (4 US gpm)	30 l/min (8 US gpm)	60 l/min (16 US gpm)	50 l/min (13 US gpm)	100 l/min (26 US gpm)
Max. pressure	350 bar (5100 psi)				
Oil leakage	at 100 bar (1450 psi)	0.25 cm ³ /min (0.015 in ³ /min)	0.25 cm ³ /min (0.015 in ³ /min)	0.25 cm ³ /min (0.015 in ³ /min)	0.25 cm ³ /min (0.015 in ³ /min)
Fluid	mineral based oil				
Viscosity	10-200 cSt				
Max level of contamination	20/18/14 ISO4406				
Fluid temperature	with NBR seals		from -20°C (-4°F) to 80°C (176°F)		
	with FPM seals		from -20°C (-4°F) to 100°C (212°F)		
Environmental temp. for working conditions	from -20°C (-4°F) to 50°C (122°F)				
Cavity	SAE 08/3	SAE 10/3	SAE 10/3	SAE 12/3	SAE 16/3
Weight	0.080 kg (0.18 lb)	0.100 kg (0.22 lb)	0.111 kg (0.24 lb)	0.230 kg (0.51 lb)	0.440 kg (0.97 lb)

NOTE - For different conditions, please contact Walvoil Sales Dpt.

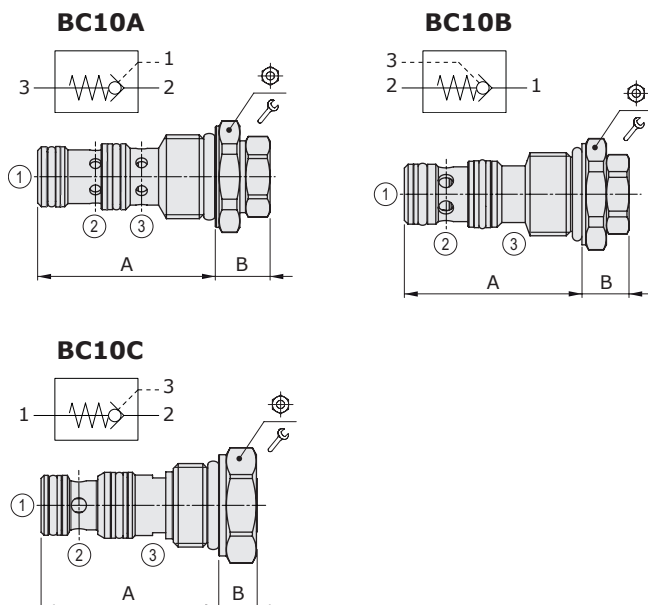

Valve type	A		B		⊕	⌘	Nm	lbft
	mm	in	mm	in				
BC..A	SAE 08/3	40.8	1.61	15.5	0.61	24	30	22
	SAE 10/3	47	1.85	11	0.43	27	50	36
	SAE 12/3	73.5	2.89	14	0.55	32	80	59
	SAE 16/3	75.4	2.97	25	0.98	41	100	73
BC..B	SAE 10/3	47	1.85	6.5	0.25	27	50	36
	SAE 12/3	73.5	2.89	14	0.55	32	80	59
	SAE 16/3	99	3.90	24	0.94	41	100	73
BC..C	SAE 10/3	47	1.85	10.2	0.40	27	50	36

Ordering codes and description composition

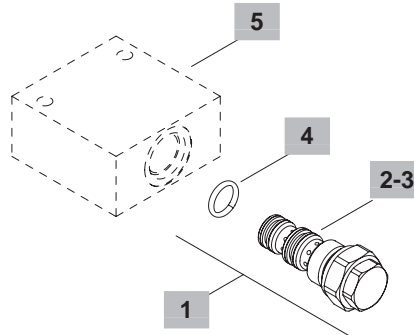
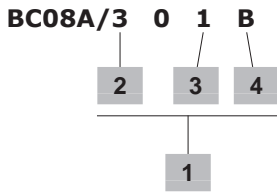

1 Cartridges

TYPE	CODE	DESCRIPTION
SAE cavity 08/3		
BC08A/301B	OBC08002000	Pilot ratio 1:2.5 Opening press. 2 to 3 = 5 bar (72.5 psi)
SAE cavity 10/3		
BC10A/301B	OBC10002001	Pilot ratio 1:3 Opening press. 2 to 3 = 5 bar (72.5 psi)
BC10B/301B	OBC10002008	Pilot ratio 1:2 Opening press. 1 to 2 = 5 bar (72.5 psi)
BC10C/401B	OBC10002011	Pilot ratio 1:4 Opening press. 2 to 1 = 5 bar (72.5 psi)
SAE cavity 12/3		
BC12A/301B	OBC12002000	Pilot ratio 1:3 Opening press. 2 to 3 = 5 bar (72.5 psi)
BC12B/301B	OBC12002005	Pilot ratio 1:3 Opening press. 1 to 2 = 5 bar (72.5 psi)
SAE cavity 16/3		
BC16A/301B	OBC16002000	Pilot ratio 1:2.5 Opening press. 2 to 3 = 5 bar (72.5 psi)
BC16B/301B	OBC16002004	Pilot ratio 1:2.5 Opening press. 1 to 2 = 5 bar (72.5 psi)

2 Pilot ratio

TYPE	DESCRIPTION
For BC..A	
BC08A/3	1:2.5
BC10A/3	1:3
BC12A/3	1:3
BC16A/3	1:2.5
For BC..B	
BC10B/3	1:2
BC12B/3	1:3
BC16B/3	1:2.5
For BC..C	
BC10B/3	1:4

3 Opening pressure from 2 to 3

TYPE	DESCRIPTION
For BC..A from 2 to 3	
1	5 bar (72.5 psi) with sealed piston
2	2.5 bar (36.2 psi) without sealed piston
For BC..B from 1 to 2	
1	5 bar (72.5 psi) with sealed piston
For BC..C from 2 to 1	
1	5 bar (72.5 psi) with seal

4 Seals

TYPE	DESCRIPTION
B	NBR (Buna) Std configuration without addition
V	For valve with FPM (Viton) o-ring seals, contact Sales Dept.

5 Valve body

TYPE	CODE	DESCRIPTION
SAE 08/3-G 3/8	3CC0830C11	Aluminium body for cavity 08 valve, G3/8 std thread
SAE 10/3-G 3/8	3CC1030C11	Aluminium body for cavity 10 valve, G3/8 std thread
SAE 12/3-G 3/8	3CC1230D11	Aluminium body for cavity 12 valve, G1/2 std thread
SAE 16/3-G 3/8	3CC1630E11	Aluminium body for cavity 16 valve, G3/4 std thread

Note: aluminium body can stand up to 210 bar (3050 psi)
For steel bodies or different threading see from page 217

Rating diagrams

BC08A pressure drop vs flow

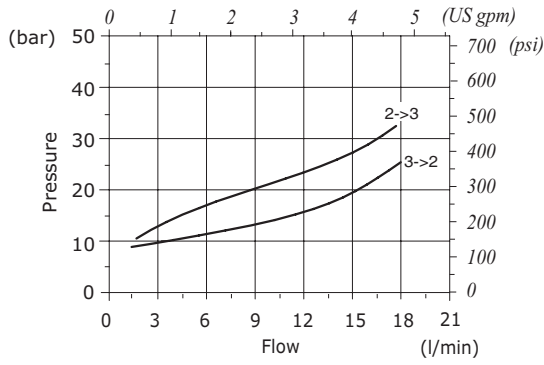

BC10A pressure drop vs flow

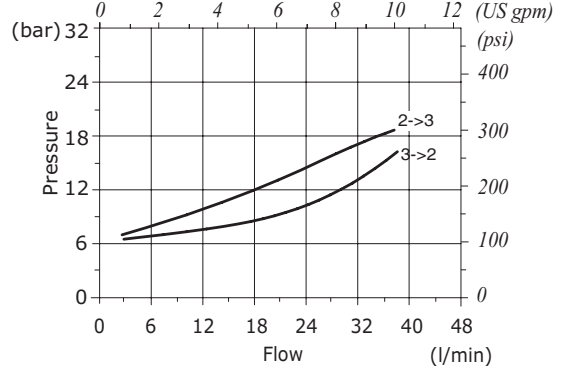

BC12A pressure drop vs flow

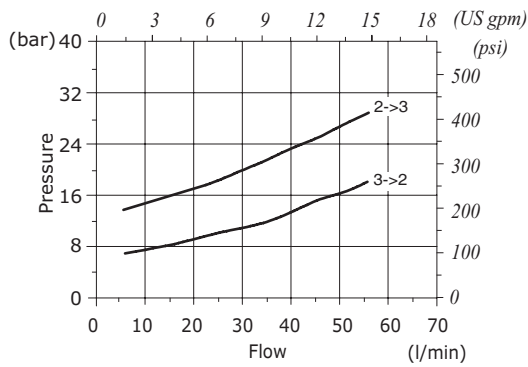

BC16A pressure drop vs flow

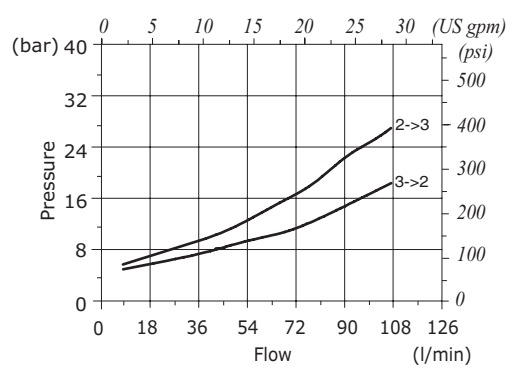

BC10B pressure drop vs flow

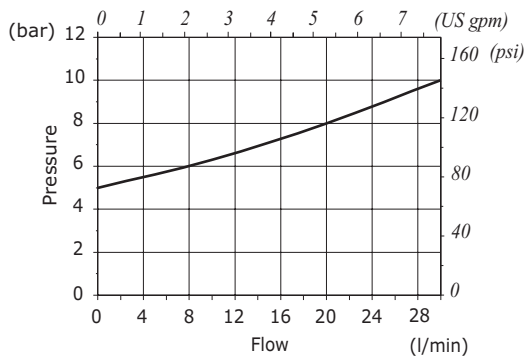

BC12B pressure drop vs flow

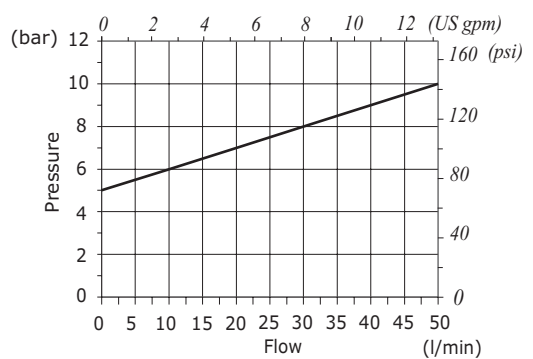

Rating diagrams

BC16B pressure drop vs flow

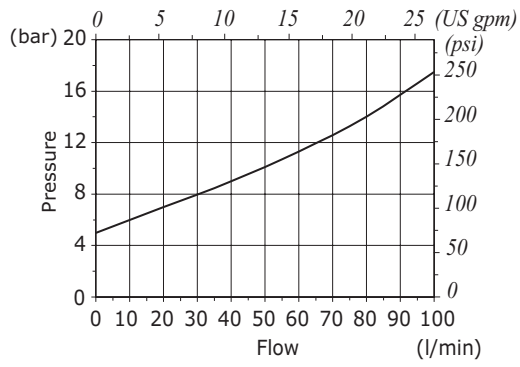

BC10C pressure drop vs flow

