



Type VABAL/SF counterbalance valves

- Cross line, relief valve for motion control
- Load sensitive

Technical specifications and diagrams are measured with mineral oil of 46 cSt viscosity at 40°C (104°F) temperature.

	VABAL/SF 38	VABAL/SF 12	VABAL/SF 34	VABAL/SF 100	
Nominal flow	35 l/min (9.2 US gpm)	70 l/min (18.5 US gpm)	100 l/min (26.4 US gpm)	180 l/min (47.6 US gpm)	
Max. pressure	Aluminium body = 210 bar (3050 psi) Steel body = 350 bar (5100 psi)				
Oil leakage	0.25 cm ³ /min - 0.015 in ³ /min. (5 drops) at 210 bar - 3050 psi at 80% of pressure setting				
Fluid	mineral based oil				
Viscosity	from 10 to 200 cSt				
Max. level of contamination	18/16/13 ISO4406				
Fluid temperature	with NBR seals from -20°C (-4°F) to 80°C (176°F)				
Environmental temp. for working conditions	from -40°C (-40°F) to 100°C (212°F)				
Weight	aluminium	2.73 kg (6.02 lb)	2.50 kg (5.51 lb)	4.52 kg (9.96 lb)	9.27 kg (20.44 lb)
	steel	4.31 kg (9.50 lb)	5.19 kg (11.44 lb)	9.03 kg (19.91 lb)	20.27 kg (44.69 lb)

NOTE - For different conditions, please contact Walvoil Sales Dpt.

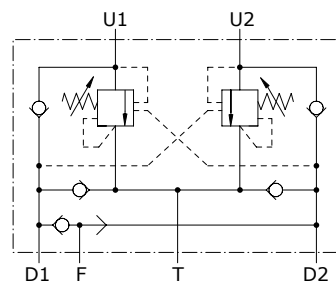

Dimensions

Valve type	D1	D2	U1	U2	T	F
VABAL 38	G3/8	G3/8	G3/8	G3/8	G1/4	G1/4
VABAL 12	G1/2	G1/2	G1/2	G1/2	G1/2	G1/4
VABAL 34	G3/4	G3/4	G3/4	G3/4	G3/4	G1/4
VABAL 100	G1"	G1"	G1"	G1"	G1"	G1/4

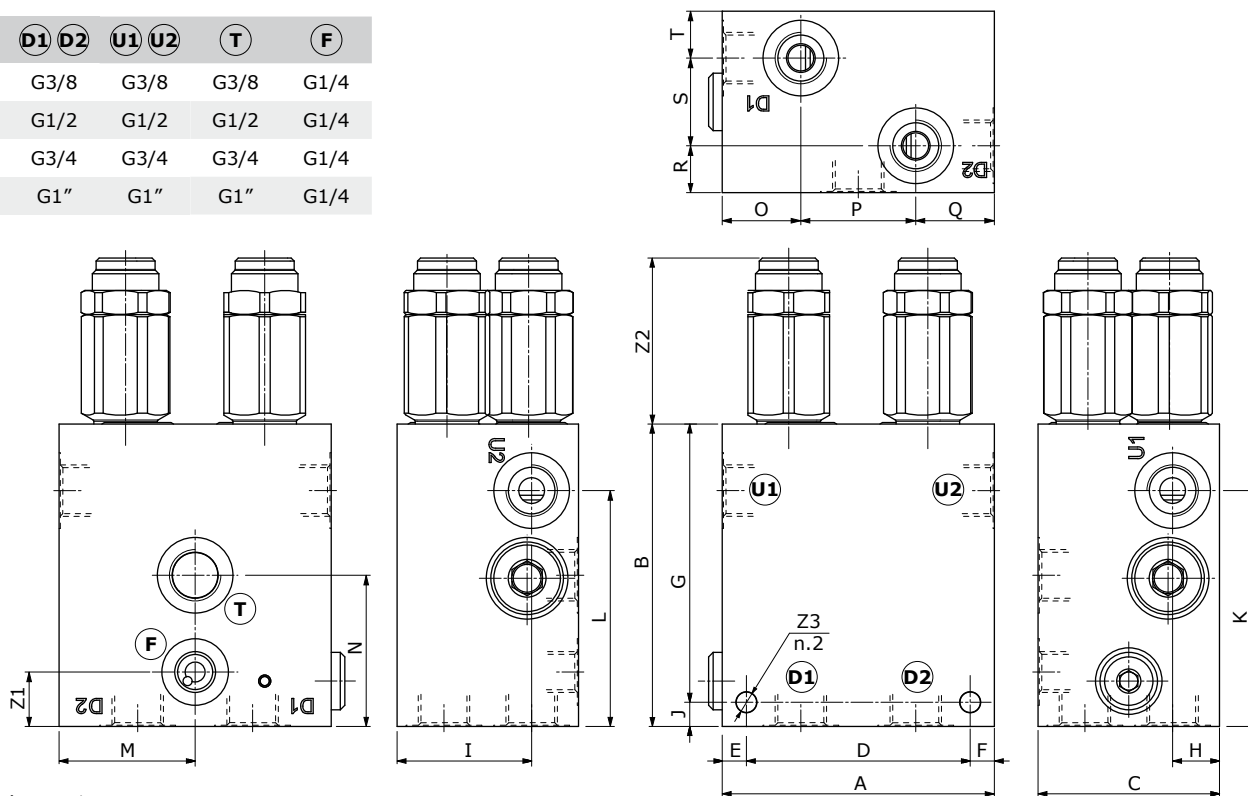

Dimensions are in mm-in

Valve type	A	B	C	D	E	F	G	J	K
VODL 38	90	100	60	74	8	8	92	8	78
	3.54	3.94	2.36	2.91	0.315	0.315	3.62	0.315	3.07
VODL 12	100	100	70	84	8	8	92	8	78.5
	3.94	3.94	2.76	3.31	0.315	0.315	3.62	0.315	3.09
VODL 34	120	120	85	100	10	10	110	10	90
	4.72	4.72	3.35	3.94	0.394	0.394	4.33	0.394	3.54
VODL 100	160	160	110	136	12	12	148	12	130
	6.30	6.30	4.33	5.35	0.472	0.472	5.83	0.472	5.12

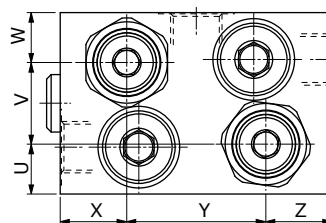

Valve type	H	I	L	M	N	O	P	Q	R	S	T	U	V	W	X	Y	Z	Z1	Z2	Z3
VODL 38	15.5	44.5	78	45	50	26	38	26	15.5	29	15.5	16.5	27	16.5	22	46	22	18	54.8	M8
	0.61	1.75	3.07	1.77	1.97	1.02	1.50	1.02	0.61	1.14	0.61	0.65	1.06	0.65	0.87	1.81	0.87	0.71	2.16	
VODL 12	17.5	52.5	78.5	50	48	29	42	29	17.5	35	17.5	18.5	33	18.5	27	46	27	18	50.2	M8
	0.69	2.07	3.09	1.97	1.89	1.14	1.14	1.14	0.69	1.38	0.69	0.73	1.30	0.73	1.06	1.81	1.06	0.71	1.98	
VODL 34	21	64	90	60	55	33	54	33	21	43	21	24	37	24	28	64	28	20	60.8	M10
	0.83	2.52	3.54	2.36	2.17	1.30	2.13	1.30	0.83	1.70	0.83	0.94	1.46	0.94	1.10	2.52	1.10	0.79	2.39	
VODL 100	30	80	130	80	84	47	66	47	30	50	30	30	50	30	47	66	47	27	64.7	M12
	1.18	3.15	5.12	3.15	3.31	1.85	2.60	1.85	1.18	1.97	1.18	1.18	1.97	1.18	1.85	2.60	1.85	1.06	2.54	

Ordering codes

VABAL/SF complete valves

TYPE: **VABAL/SF 38/TR.S.p3** CODE: 1572021103
 DESCRIPTION: Aluminium body, G3/8 ports, pilot ratio 1:3, range 50-350 bar (725-5075 psi), std setting 280 bar (4060 psi) @ 5 l/min (1.32 US gpm)

TYPE: **VABAL/SF 12/TR.S.p3** CODE: 1572031103
 DESCRIPTION: Aluminium body, G1/2 ports, pilot ratio 1:3, range 50-350 bar (725-5075 psi), std setting 280 bar (4060 psi) @ 5 l/min (1.32 US gpm)

TYPE: **VABAL/SF 34/TR.S.p3** CODE: 1572041103
 DESCRIPTION: Aluminium body, G3/4 ports, pilot ratio 1:3, range 50-350 bar (725-5075 psi), std setting 280 bar (4060 psi) @ 5 l/min (1.32 US gpm)

TYPE: **VABAL/SF 100/TR.S.p3.PG** CODE: 1572051103
 DESCRIPTION: Aluminium body, G1" ports, pilot ratio 1:3, range 50-350 bar (725-5075 psi), std setting 280 bar (4060 psi) @ 5 l/min (1.32 US gpm)

For other configurations and steel body please contact our Sales Dept.

Rating diagrams

VABAL 38 pressure drop vs. flow from U1->D1 (U2->D2) and D1->U1 (D2->U2)

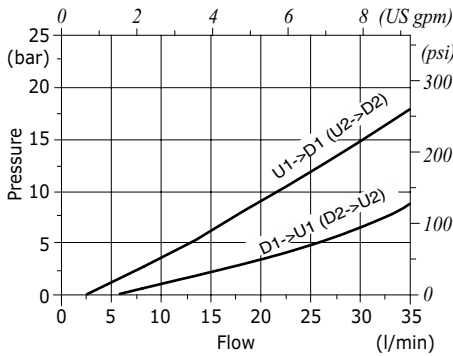

VABAL 38 pressure setting vs. flow from U1 (U2)->T

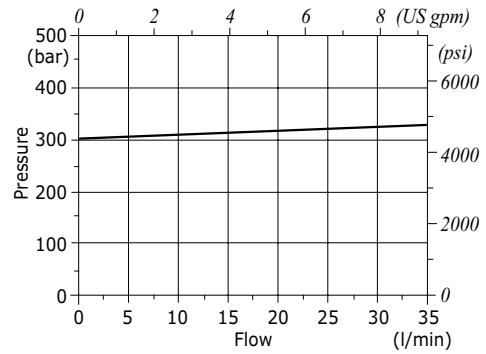

VABAL 12 pressure drop vs. flow from U1->D1 (U2->D2) and D1->U1 (D2->U2)

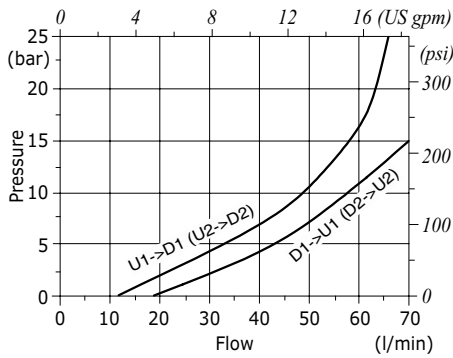

VABAL 12 pressure setting vs. flow from U1 (U2)->T

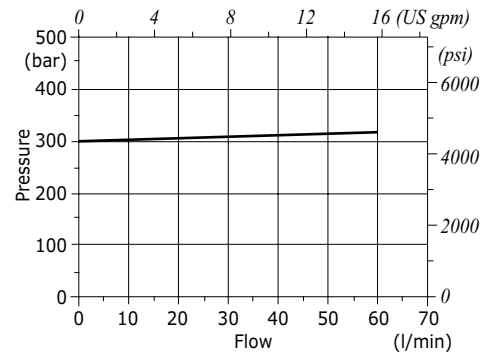

VABAL 34 pressure drop vs. flow from U1->D1 (U2->D2) and D1->U1 (D2->U2)

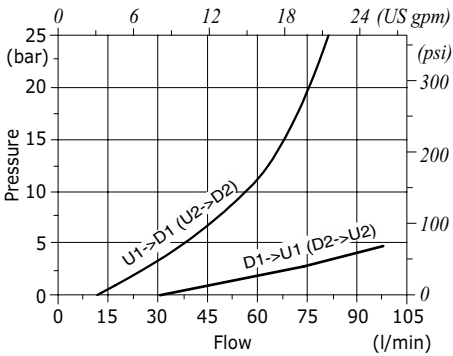

VABAL 34 pressure setting vs. flow from U1 (U2)->T

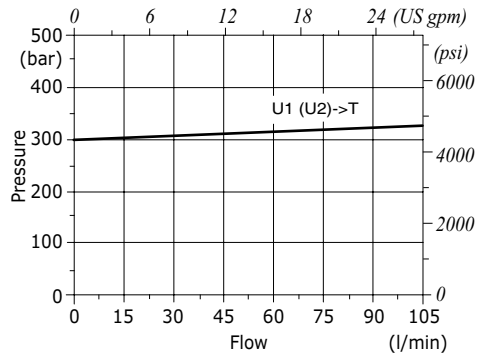

VABAL 100 pressure drop vs. flow from U1->D1 and D1->U1

